

KOTA 2TH VANITY BASIN



Product Code	CKOTJUNE2TH
Weight (Kg)	8.4
Material	Vitreous China
Tap holes	2
Fixings	Includes cutting template

Key features:

- UKCA compliant
- Chrome effect overflow ring
- Oval design
- Internal overflow
- Lifetime ceramic guarantee*

Description:

Vanity basins are designed for use with solid or composite, natural or man-made worktops. Ideal for contemporary bathrooms or commercial settings.

Overflow is opposite tap (hidden in picture).

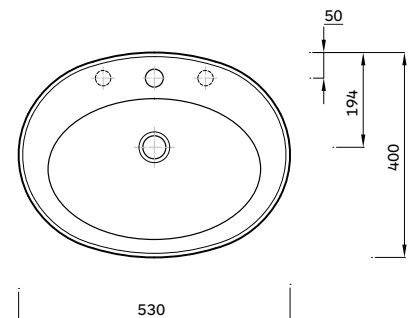
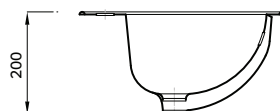
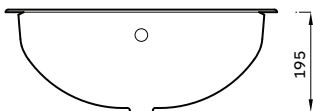

All dimensions are approximate and subject to normal ceramic variation. Although every effort is made not to change the above product specification, we reserve the right to do so without prior notification if necessary. *Against manufacturers defects. Full information on guarantees available upon request.